

Αλλαγές - Διασταυρώσεις

Αλλαγές

- Θέσεις όπου αλλάζει πορεία ο συρμός

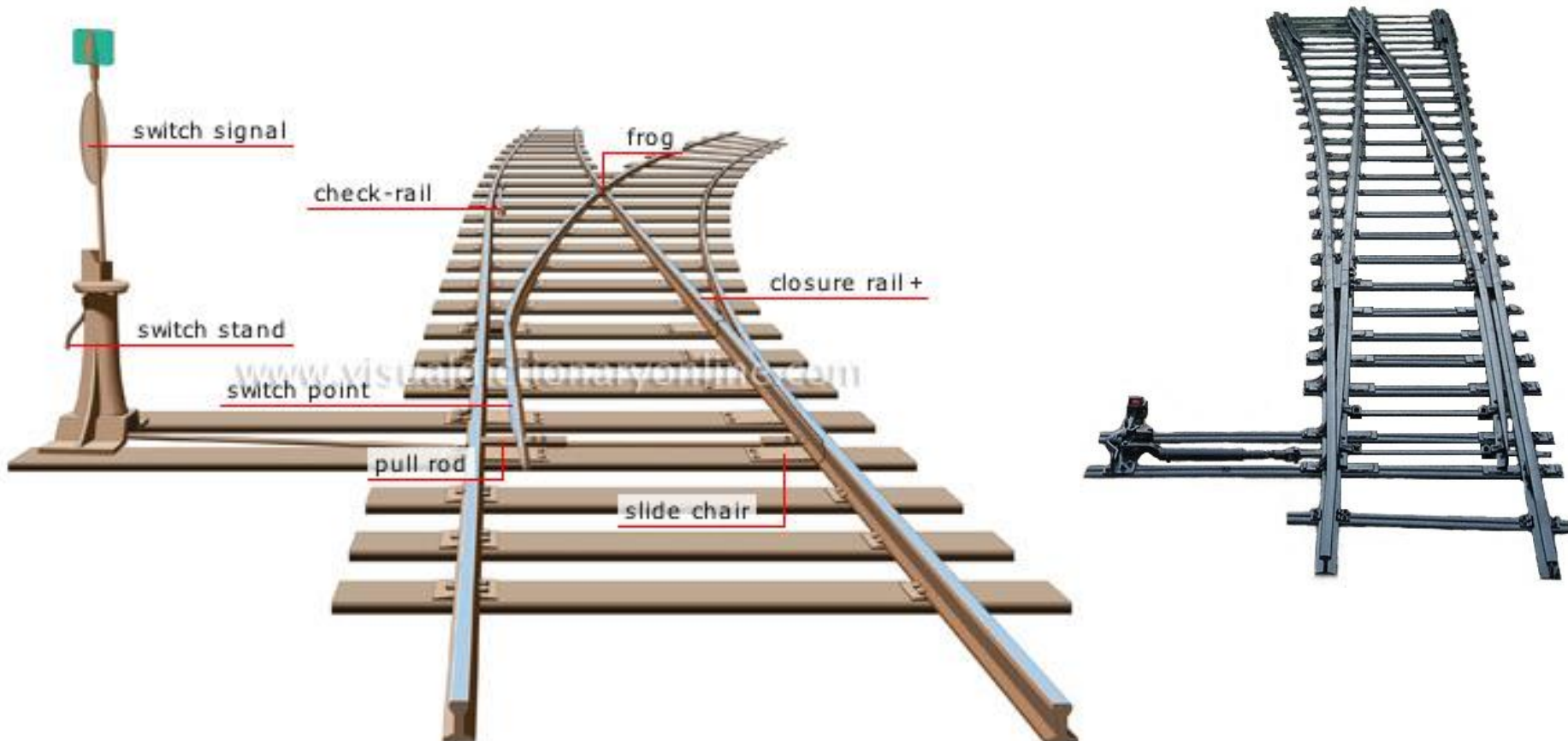

Αλλαγές

- Χαρακτηρισμός Αλλαγής

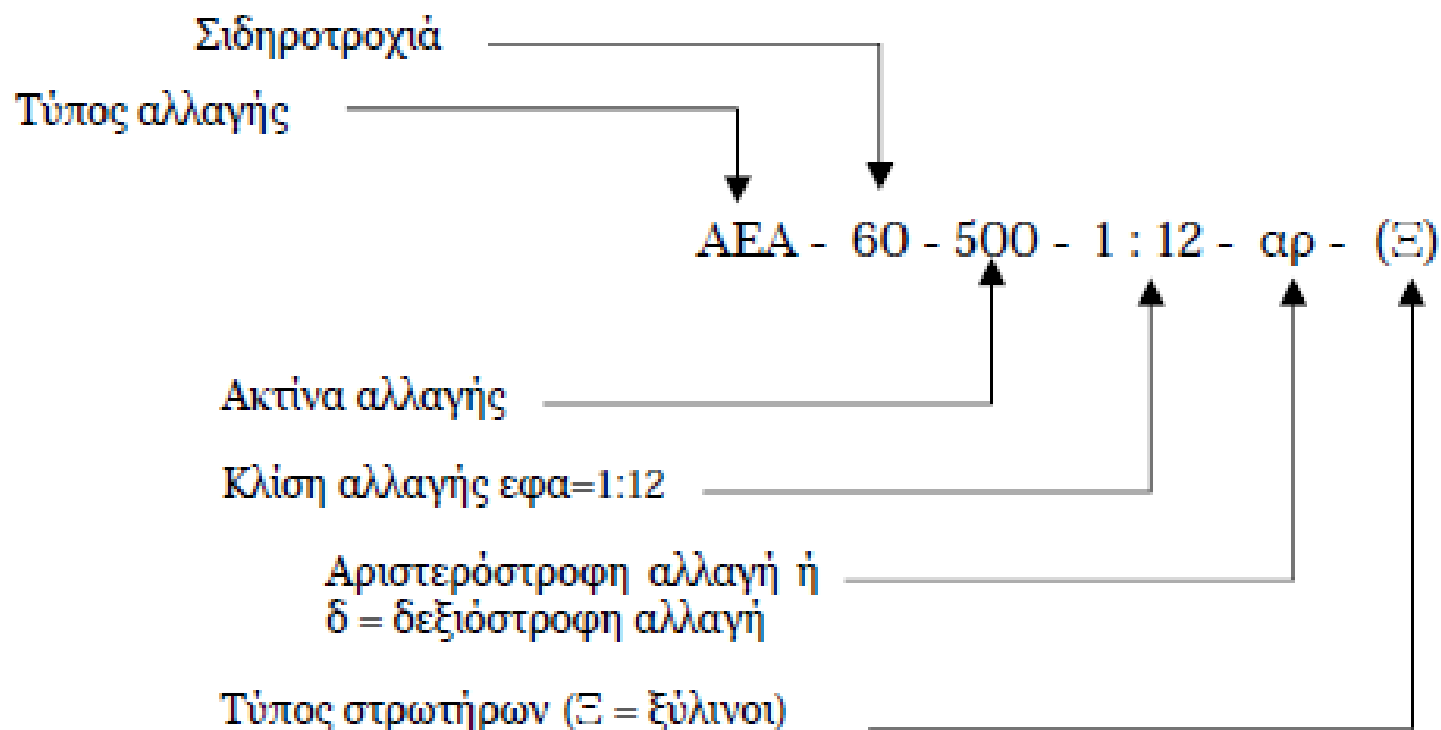

Αλλαγές

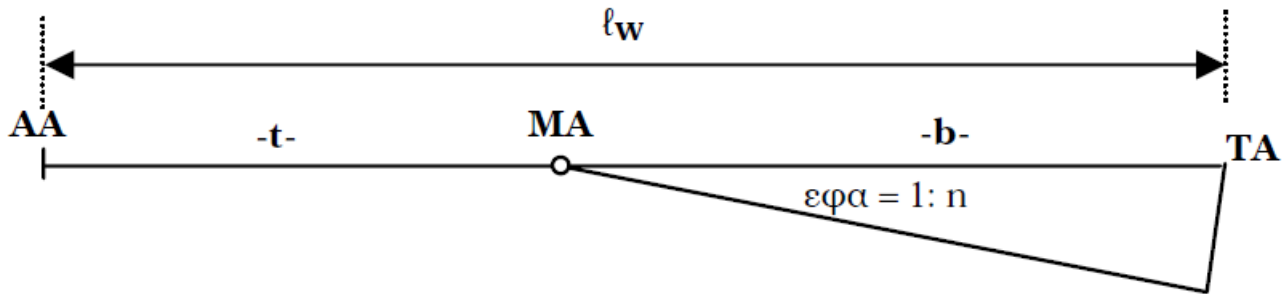
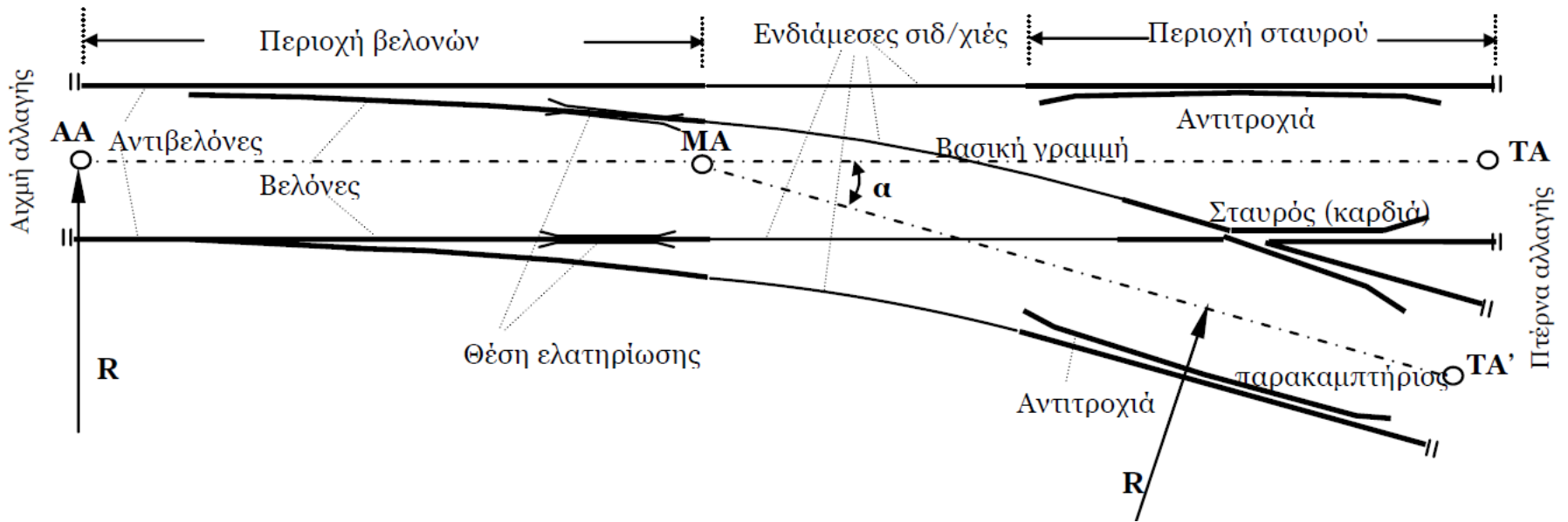

Αλλαγές

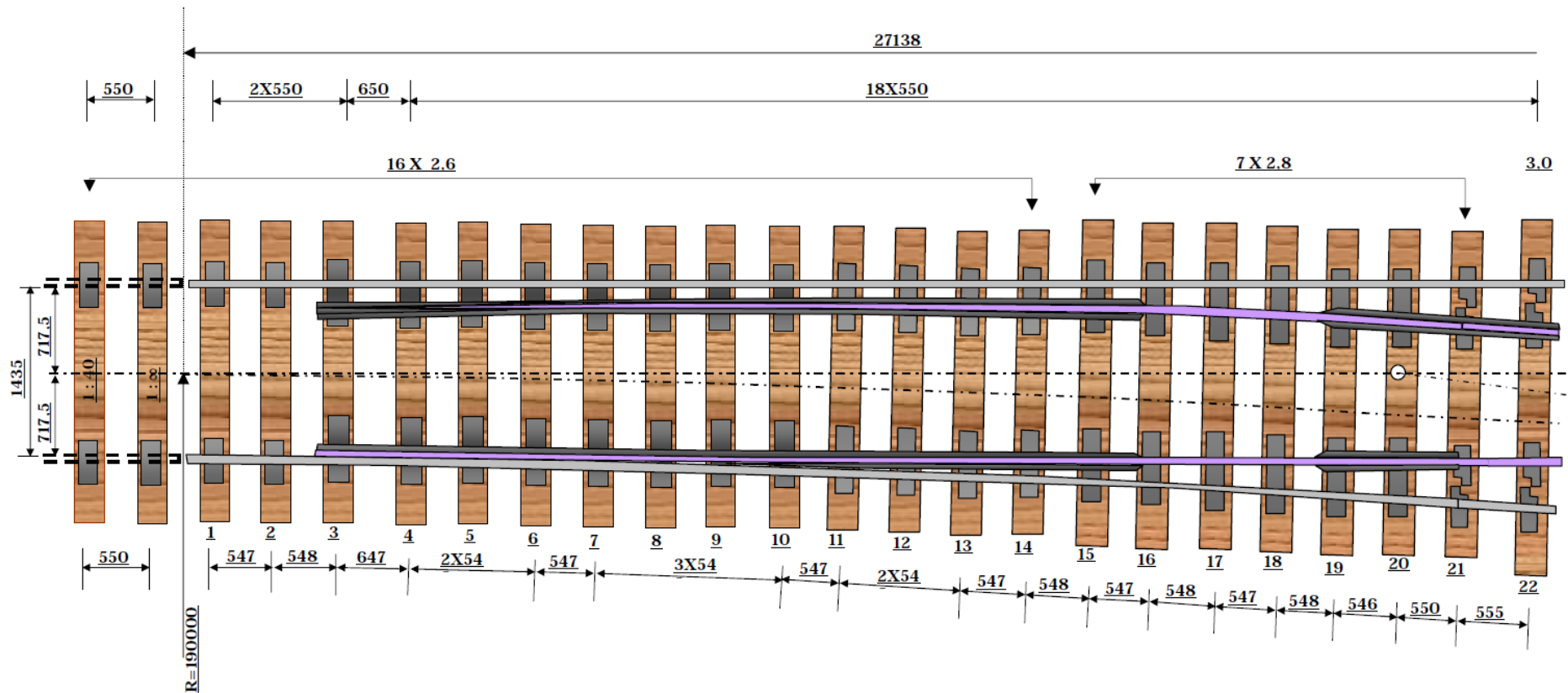

Αλλαγές

27138

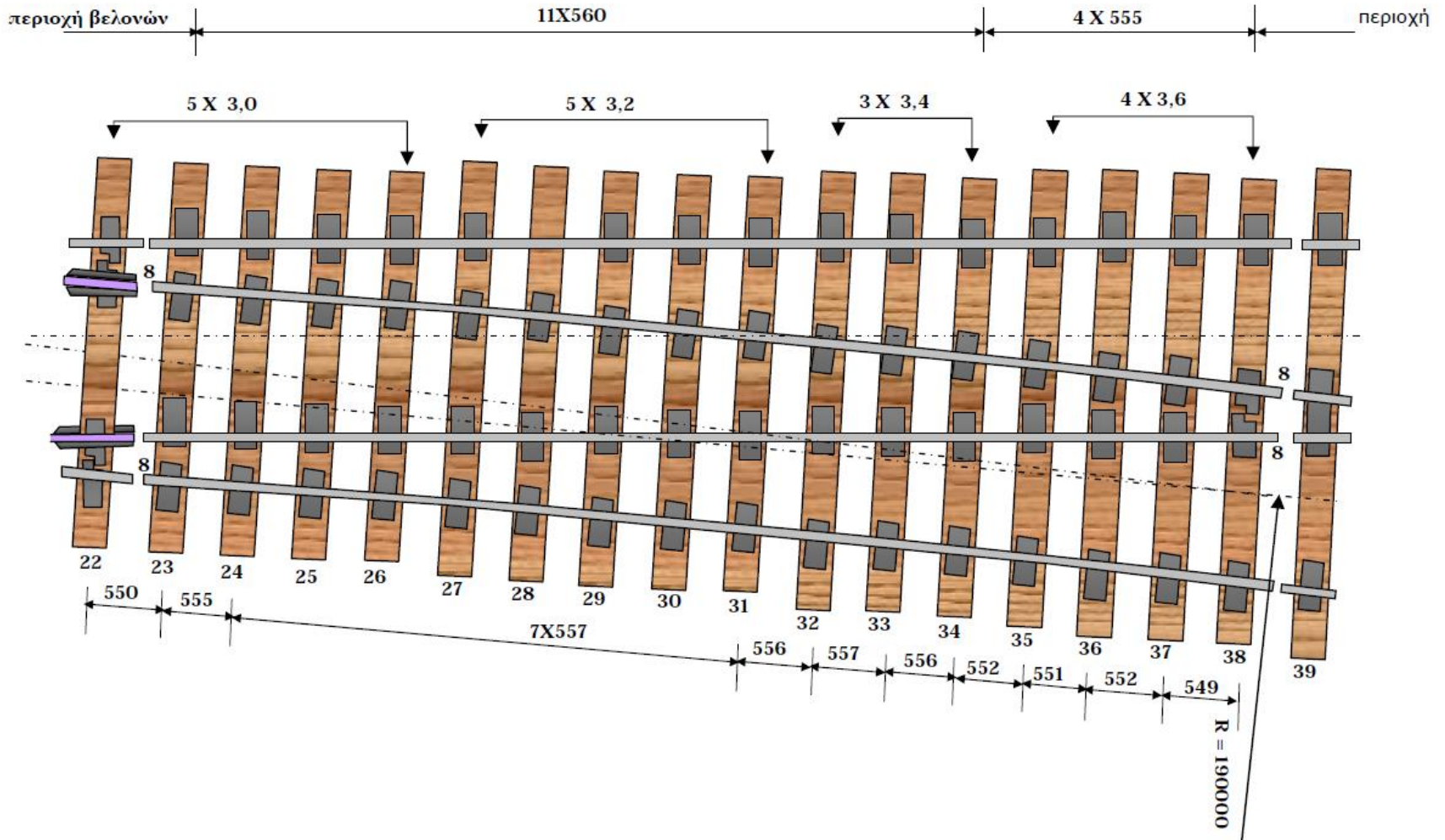

Αλλαγές

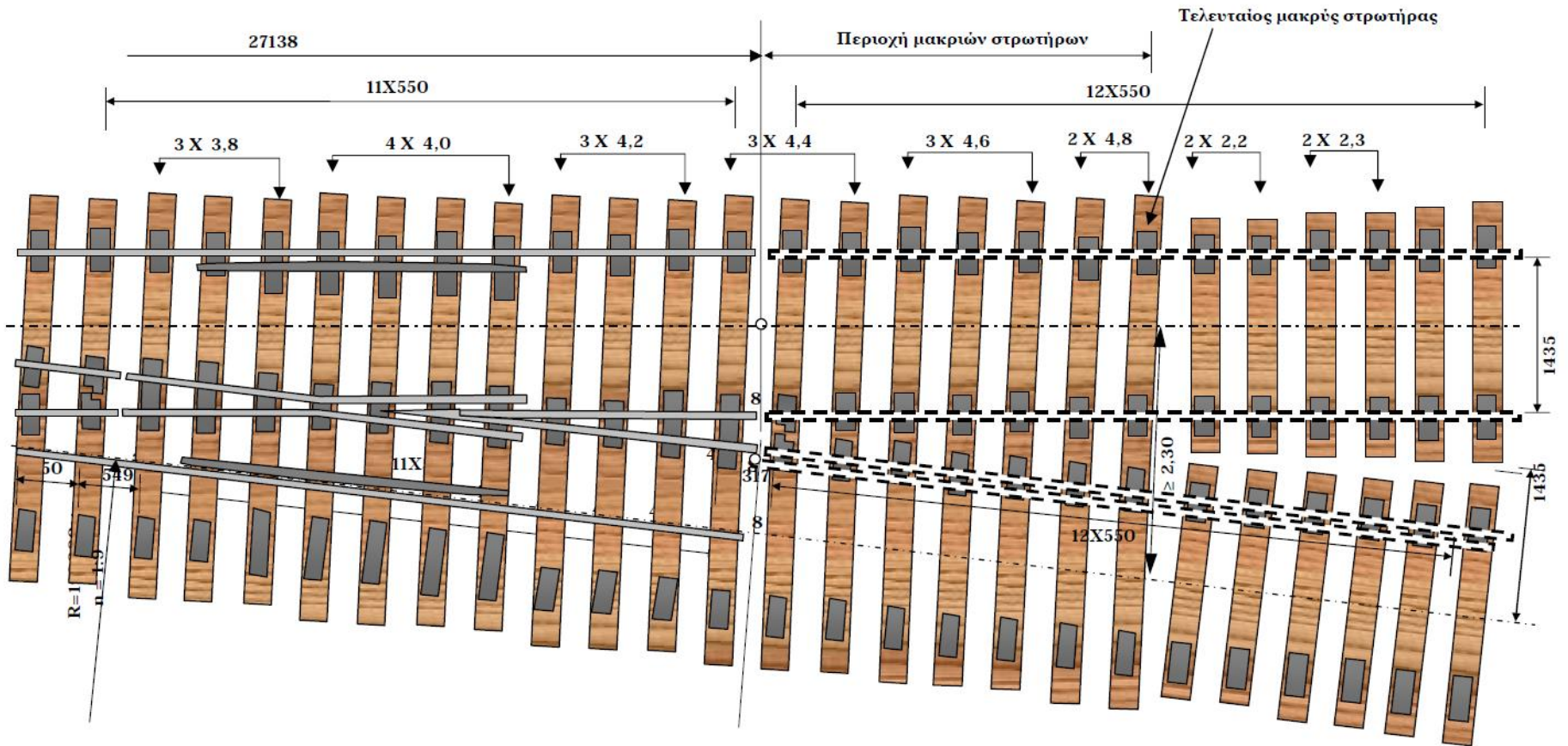

Αλλαγές

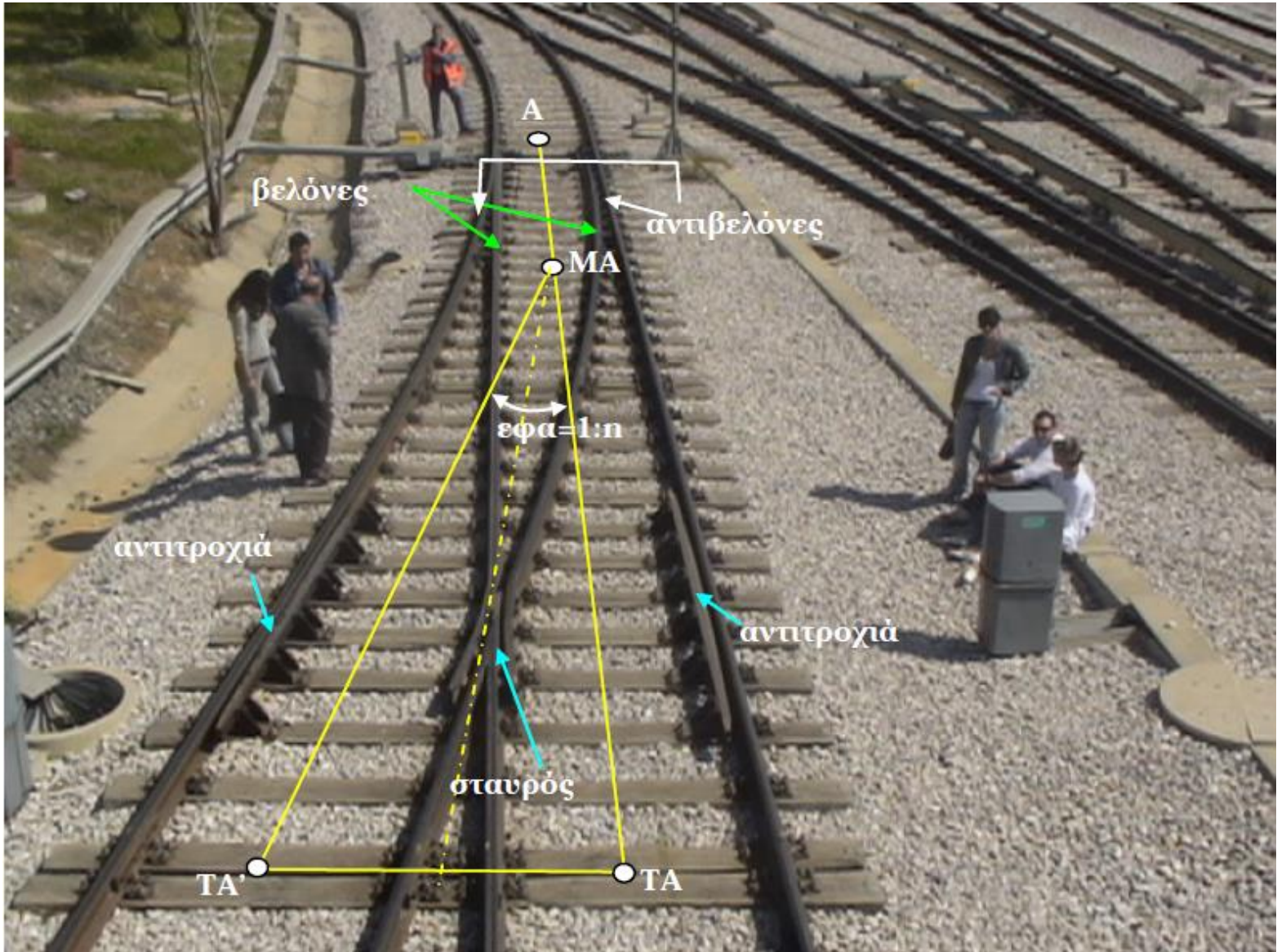

Αλλαγές

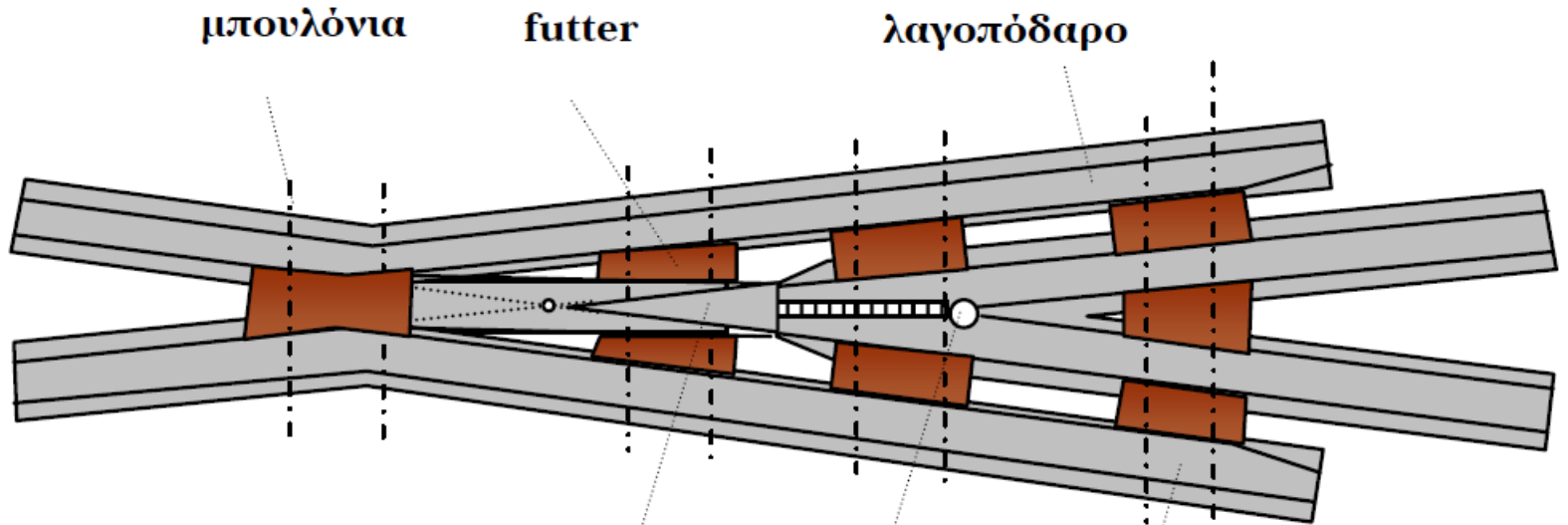

αιχμή

οπή εκτόνωσης
τάσεων

λαγοπόδαρο

Σταυρός



Αλλαγές



Κίνηση βελονών

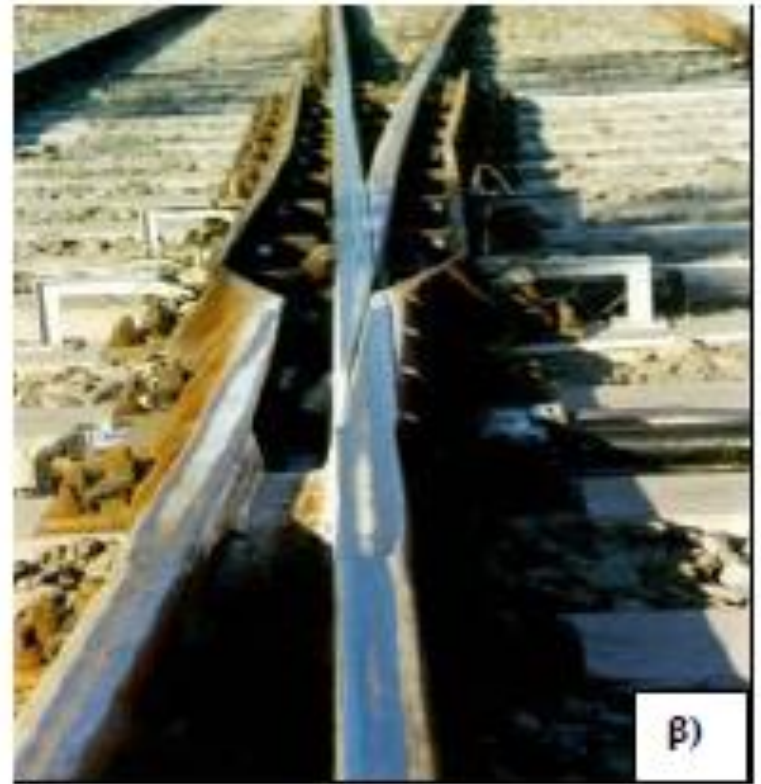

Κίνηση λαγοπόδαρου

Αλλαγές

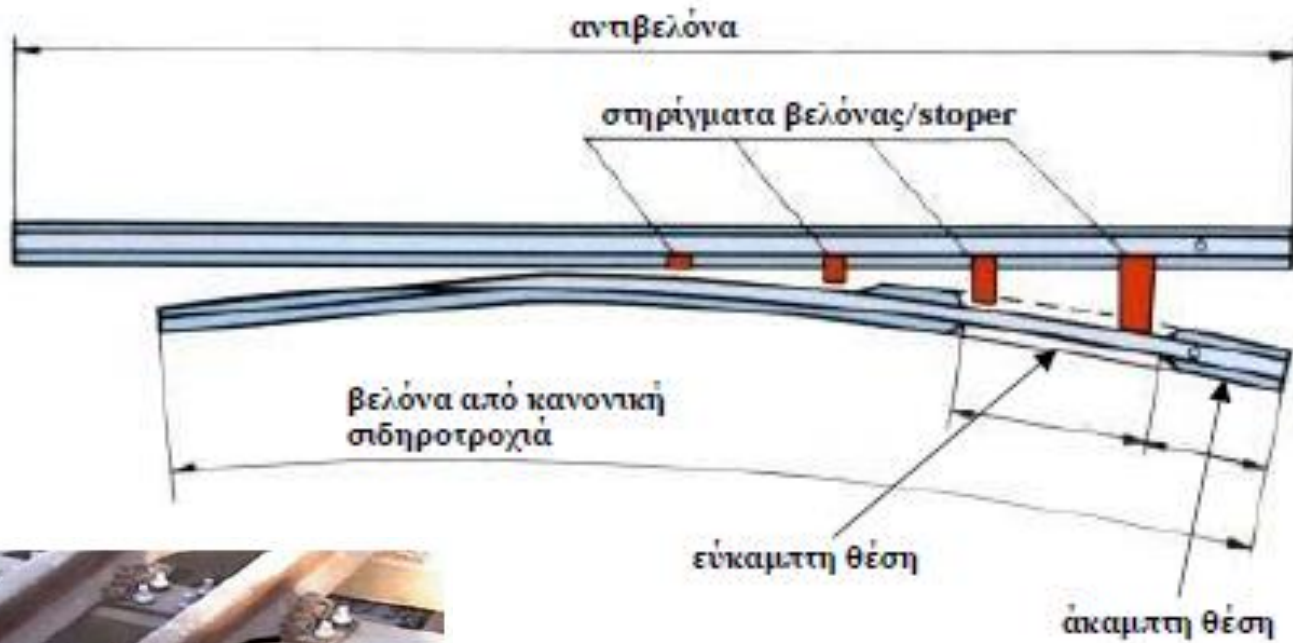

Αλλαγές

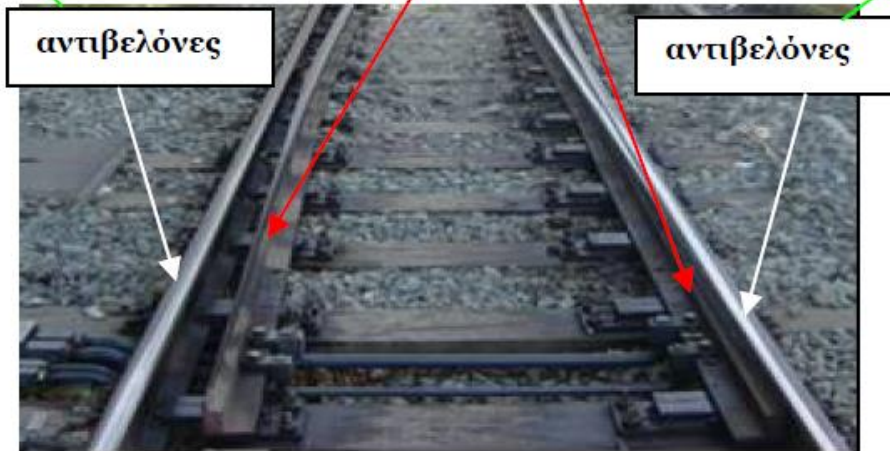
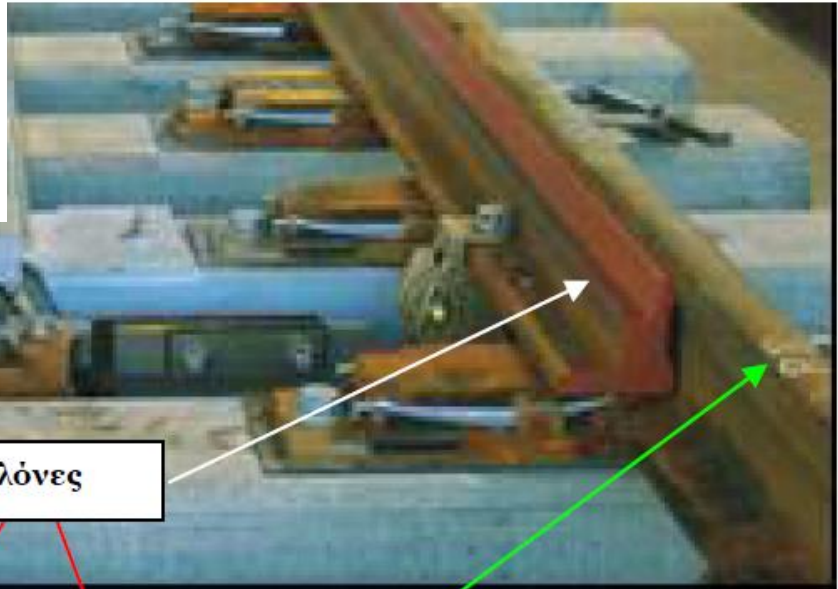
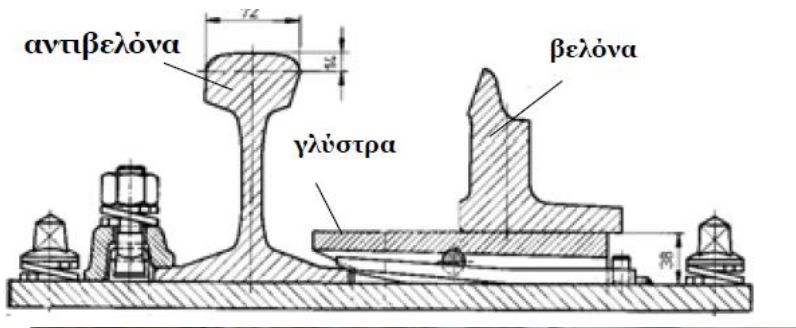

Βελόνες

Αλλαγές

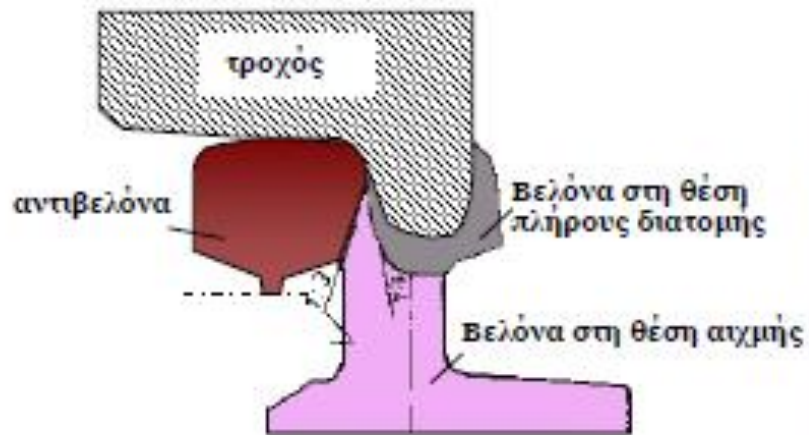
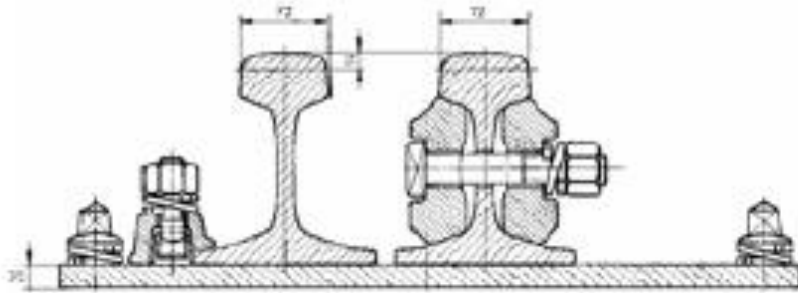

Αλλαγές

Διάκενο διέλευσης
εξωτερικού τροχού

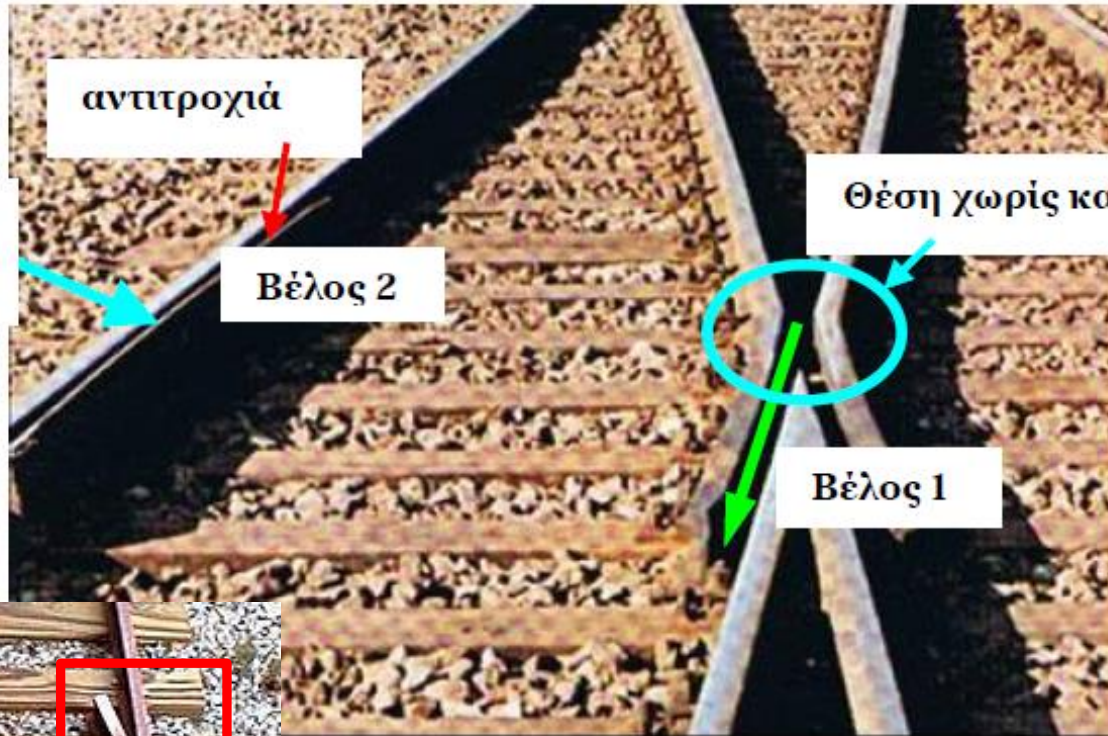

Αντιπροχιά

Διπλές Αλλαγές

Μονόπλευρες

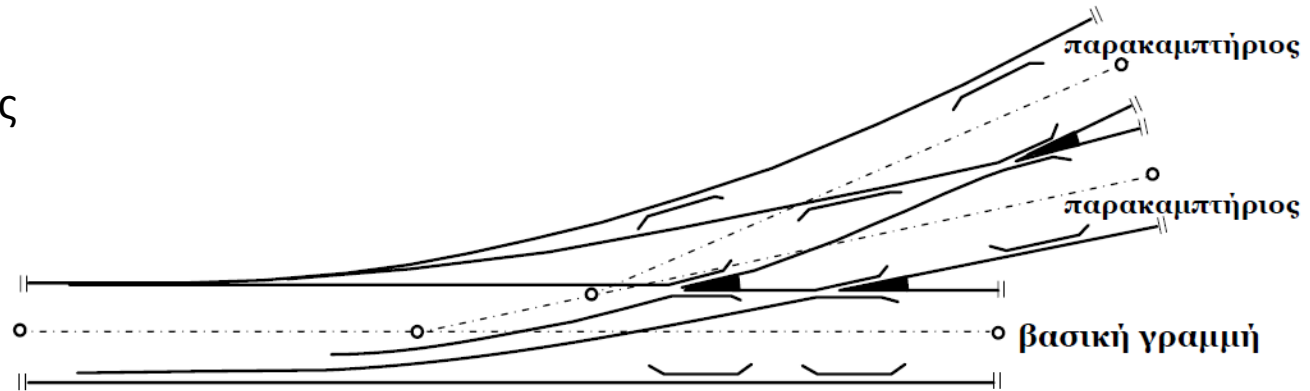

Αμφίπλευρες

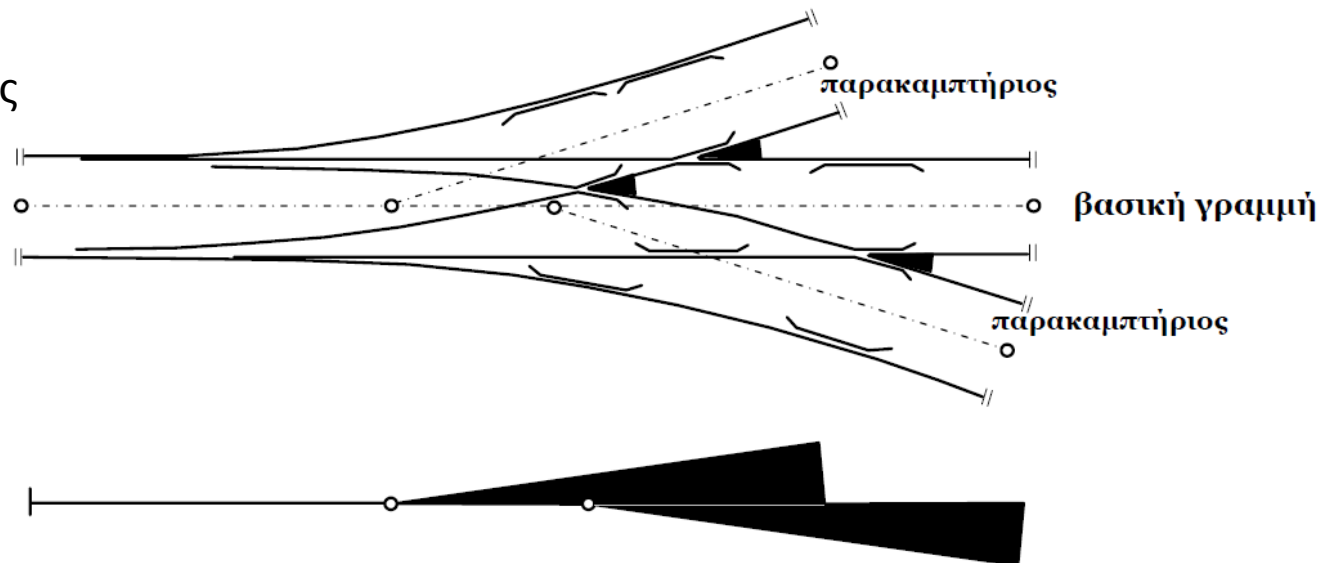

Αλλαγές

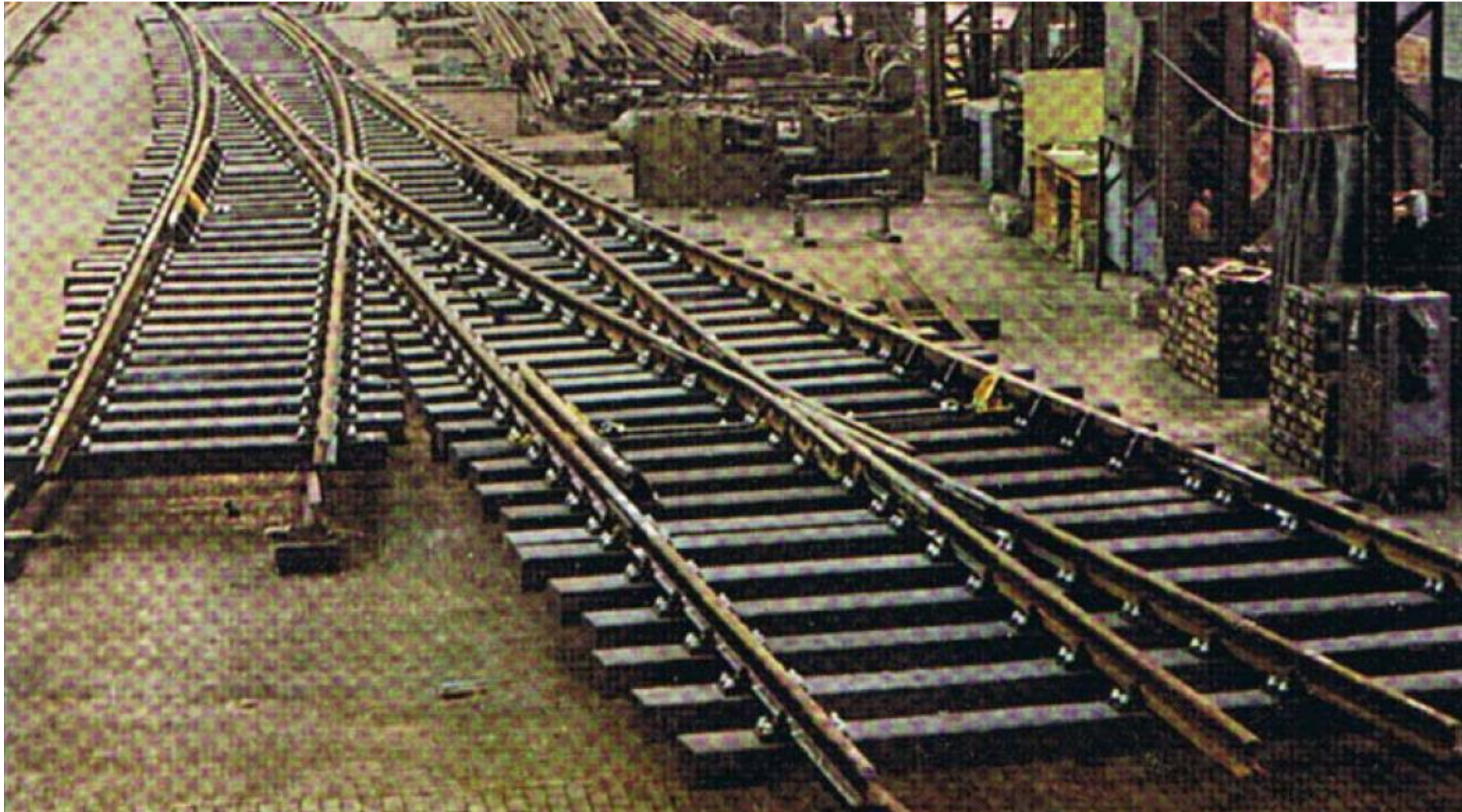

Αλλαγές

s = απόσταση του τελευταίου μακρύ στρωτήρα από το τέλος της αλλαγής

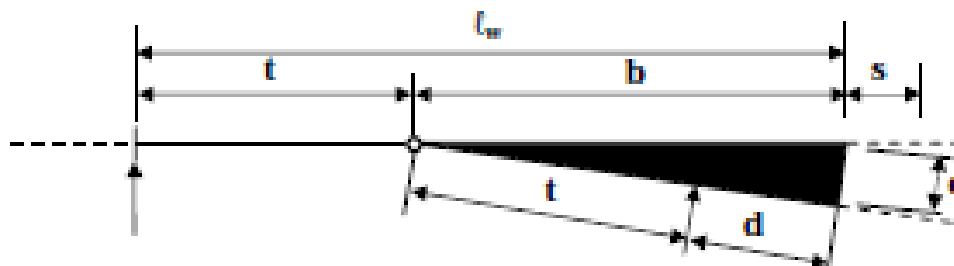

Τύπος		t [m]	b [m]	d [m]	l_w [m]	c [m]	s [m]	V [km/h]
49	190-1:9	10,5232	16,6149	6,0917	27,1381	1,8376	4,01	40
54							3,90	
49	300-1:14	10,7007	24,5374	13,8367	35,2381	1,7493	6,55	50
54							5,10	
60	300-1:14	10,7007	27,1084	16,4077	37,8090	1,9326	5,10	50
49	500-1:14	17,8344	24,5366	6,7022	42,3710	1,7491	6,60	60
54							5,10	
60	500-1:14	17,8344	27,1080	9,2736	44,9424	1,9326	5,10	60
49	760-1:18,5	20,5256	32,4087	11,8831	52,9343	1,7499	9,21	80
54							9,90	
60							9,90	

Διασταυρώσεις

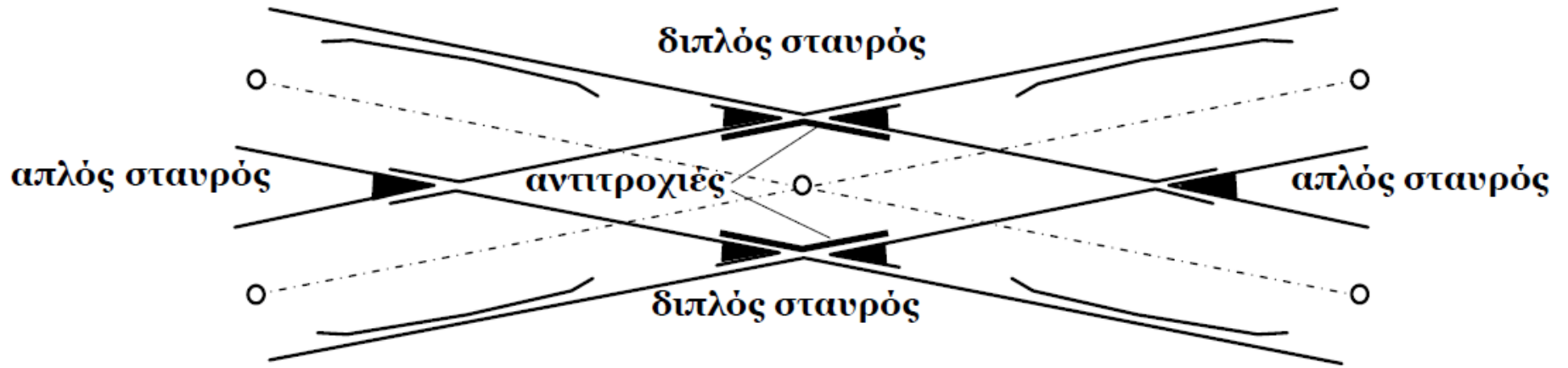

Διασταυρώσεις - Αλλαγές

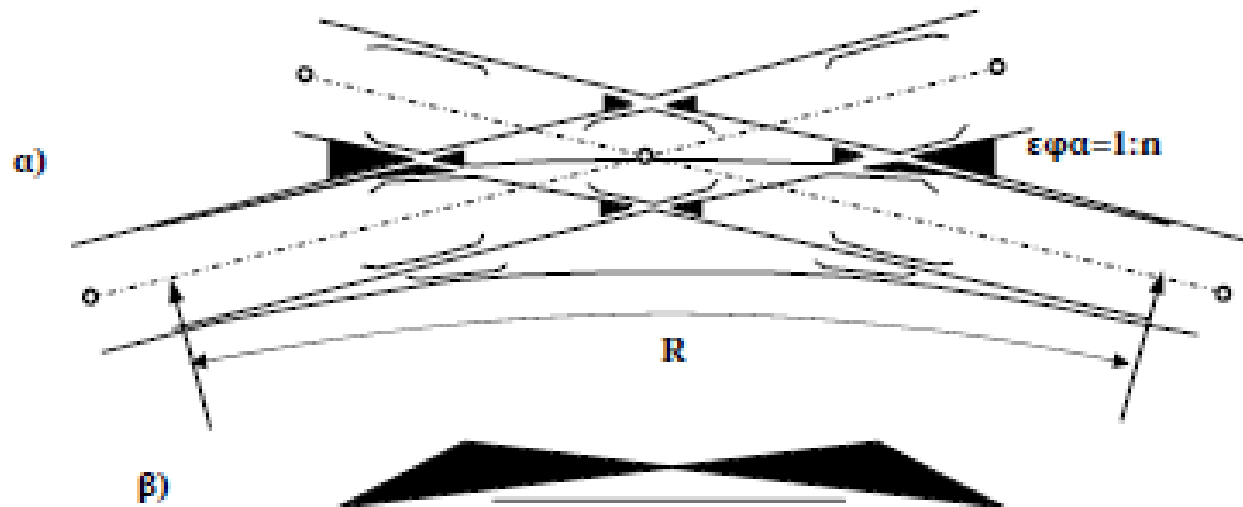
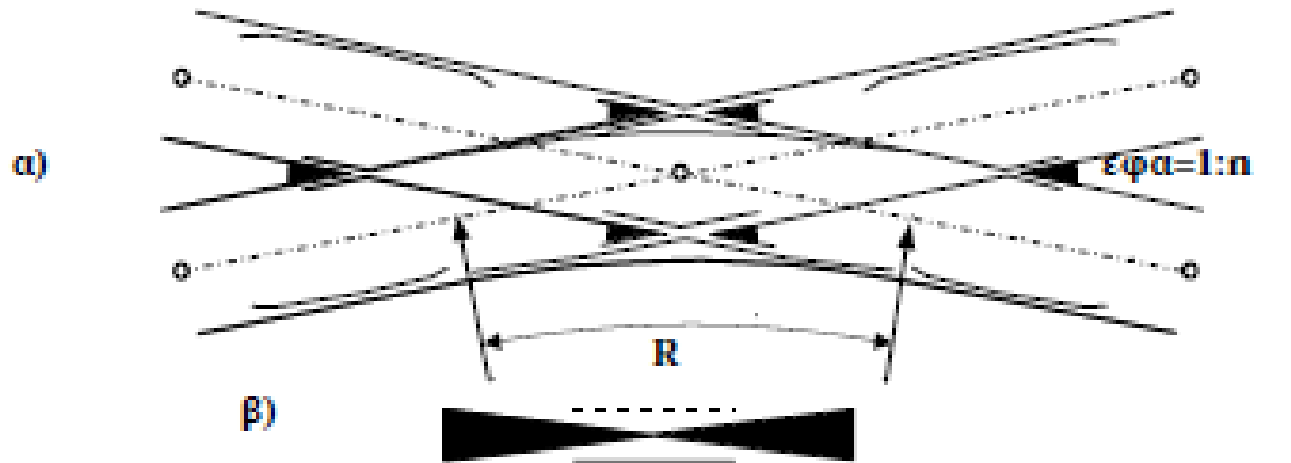

Διάταξη Αλλαγών

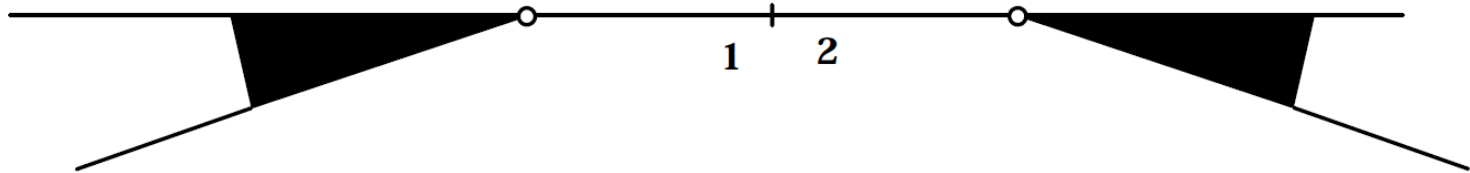

Ομόρροπα συνεχόμενες αλλαγές

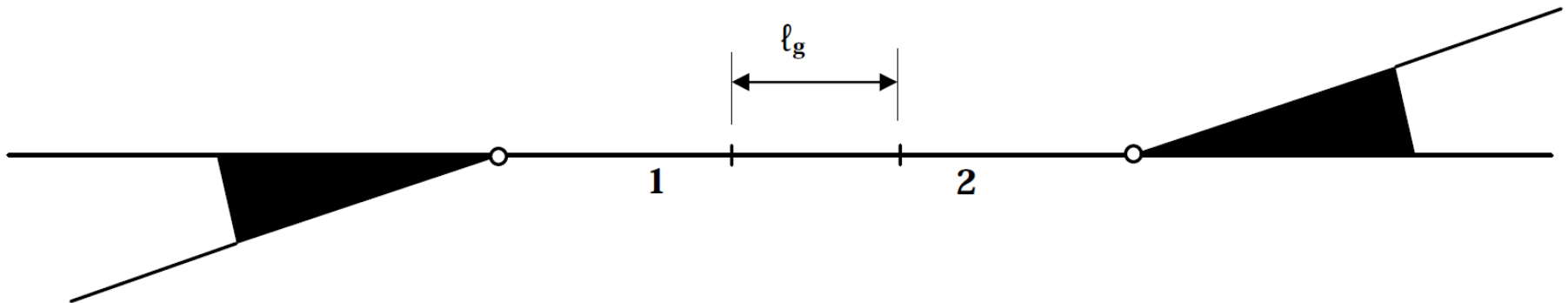

Αντίρροπα συνεχόμενες αλλαγές

Διάταξη Αλλαγών

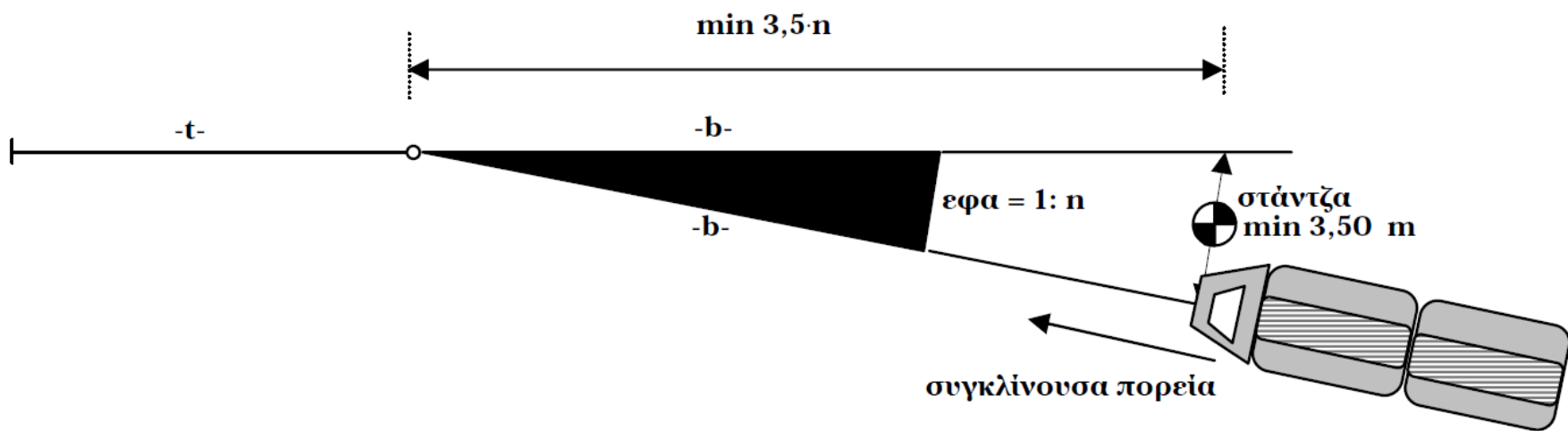

Σημείο Κινδύνου Αλλαγής

Απλή σύνδεση παράλληλων γραμμών

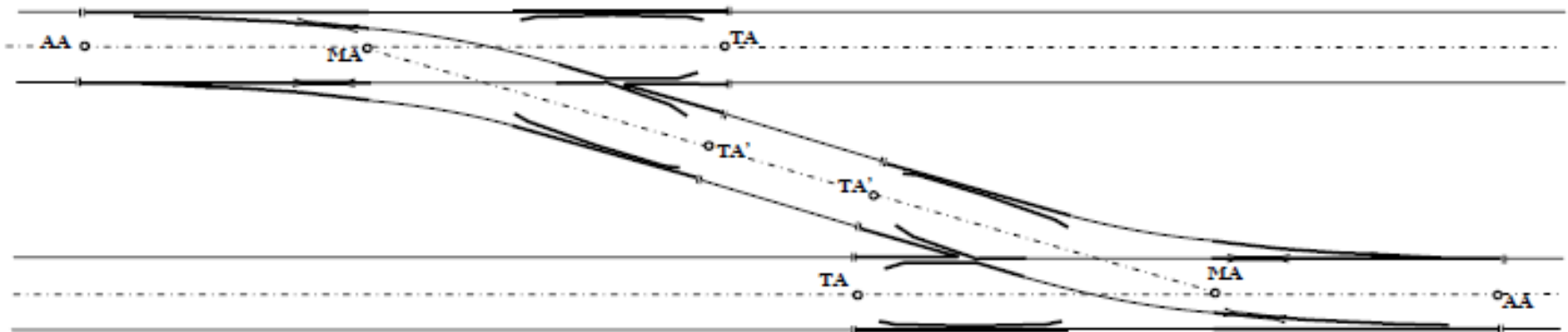
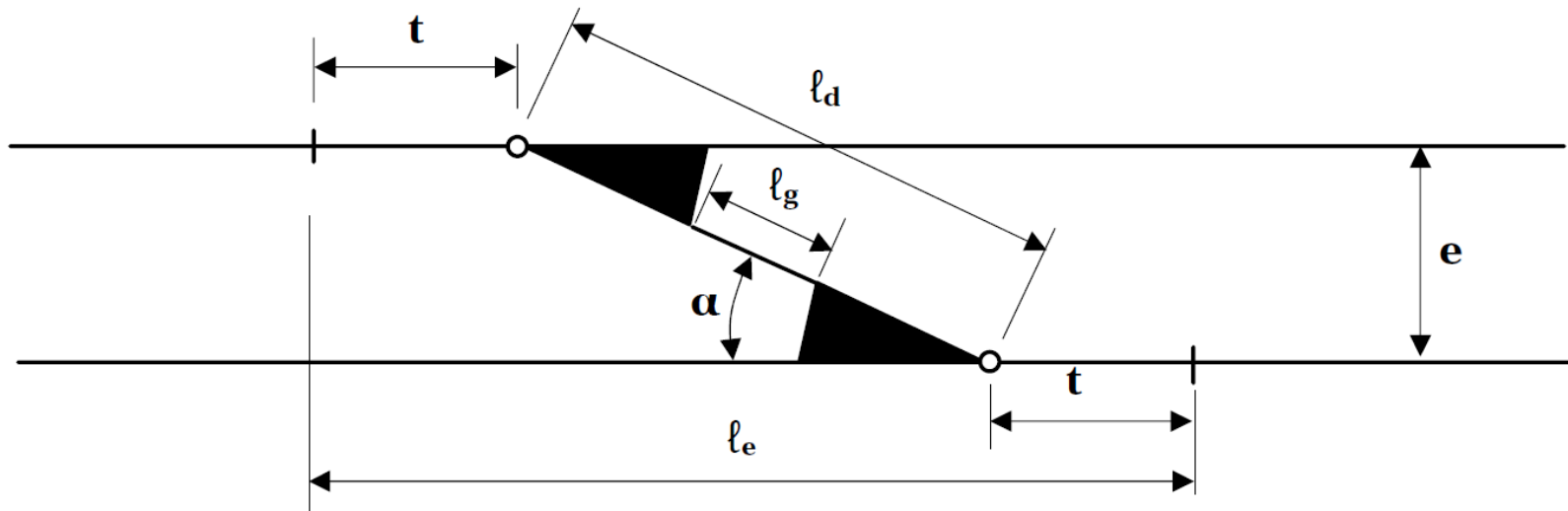

Διπλή σύνδεση παράλληλων γραμμών

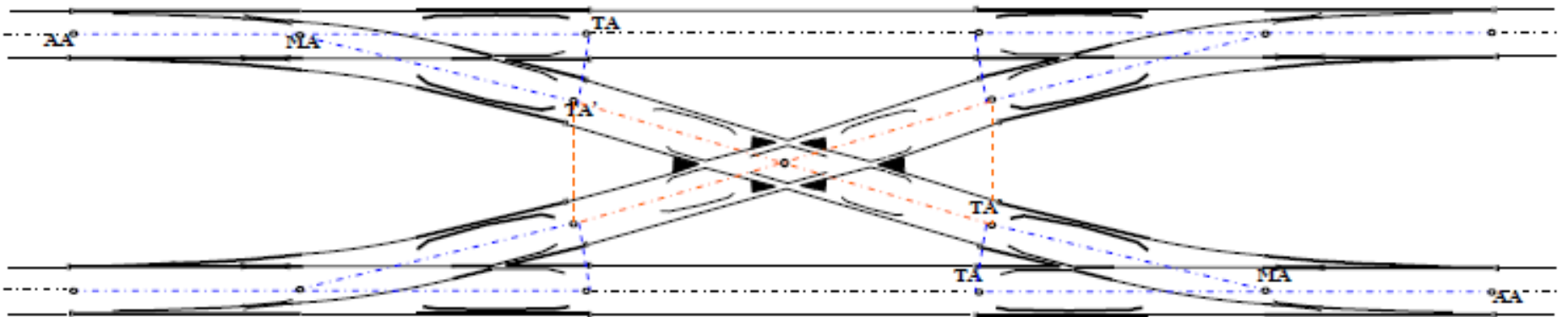
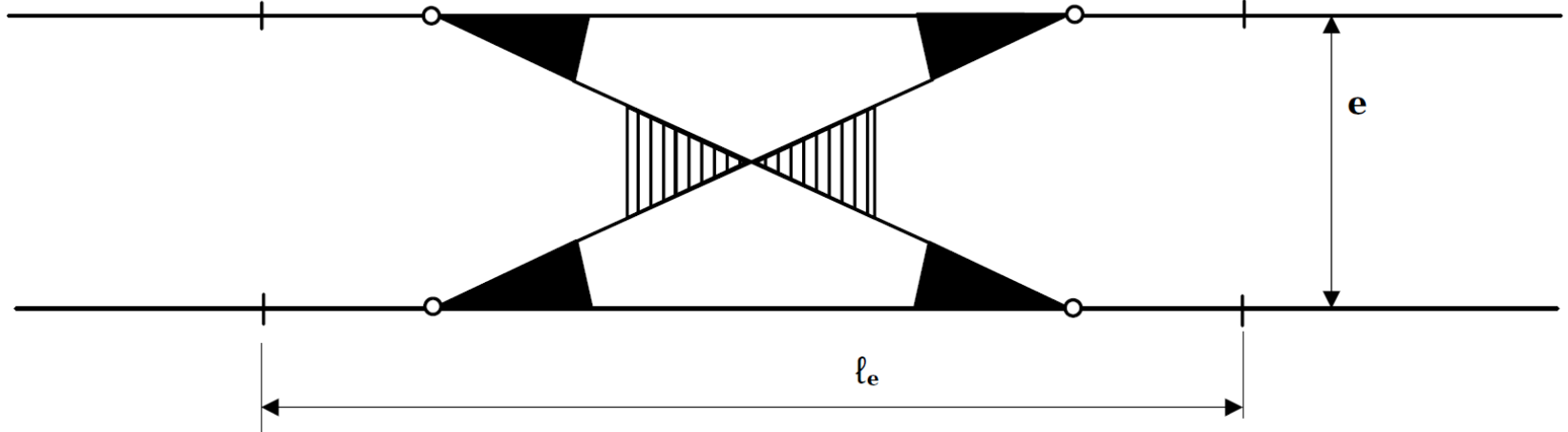

Σύνδεση 3 παράλληλων γραμμών



Με 4 απλές αλλαγές



Με 2 απλές αλλαγές και 1 διπλή

Σύνδεση παράλληλων γραμμών σε χτένι

